

## 1 Appearance



### Network Horn Speaker

Quick Start Guide

UD34183B

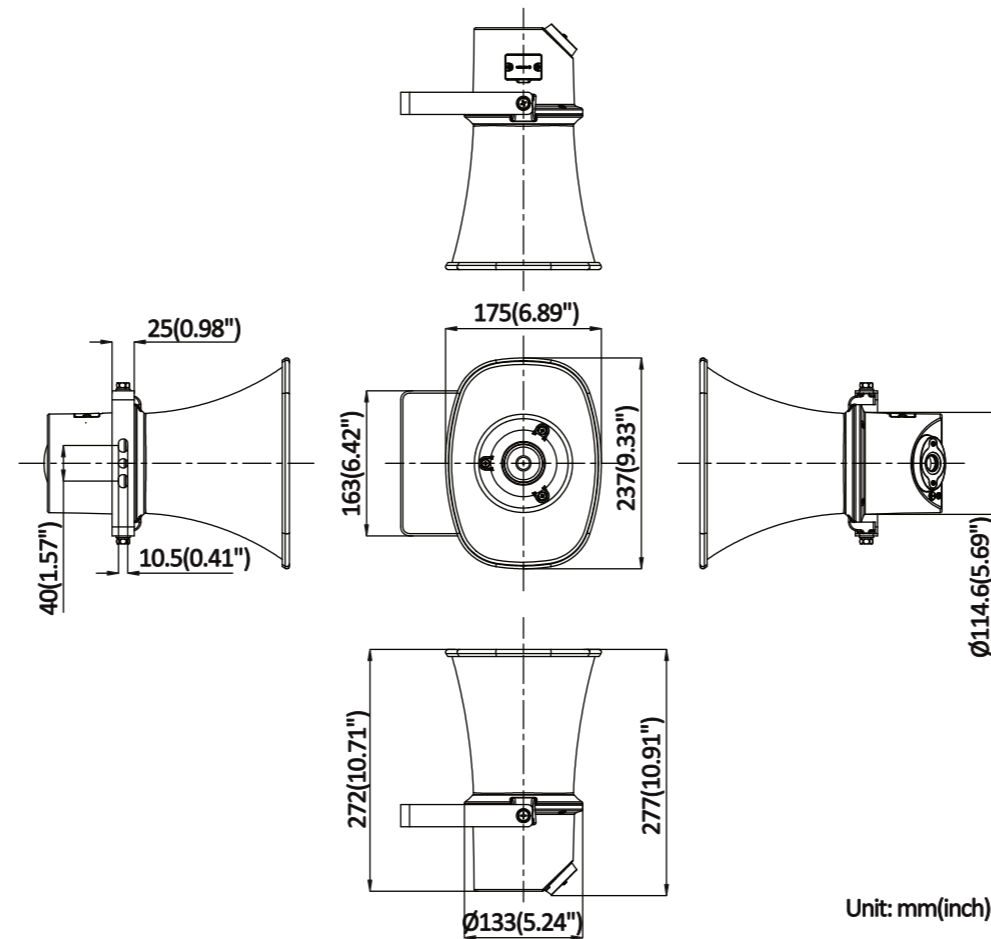

Unit: mm(inch)

#### Note

The appearance varies with the models. The actual device prevails.

#### Warning

- Refer to the device label for the standard power supply. Please make sure your power supply matches with your device.
- In the use of the product, you must be in strict compliance with the electrical safety regulations of the nation and region.
- CAUTION: If the fuse of the device can be replaced, replace it only with the same model to reduce the risk of fire or electric shock.
- CAUTION: If the device needs to be installed with a specific bracket of our company, use the corresponding bracket only. Use others (such as carts, stands, and carriers) may result in instability and cause injury. Refer to the device datasheet for bracket model details. Refer to datasheet for details.
- For the device with sound playing function, to prevent possible hearing damage, do not listen at high volume levels for long periods. Refer to the user manual for details.
- Refer to the device label for the standard power supply. Please make sure your power supply matches with your device.
- Make sure that the power has been disconnected before you wire, install, or disassemble the device.
- To avoid heat accumulation, good ventilation is required for a proper operating environment.
- If smoke, odor, or noise arises from the device, immediately turn off the power, unplug the power cable, and contact the service center.
- If the product does not work properly, please contact your dealer or the nearest service center. Never attempt to disassemble the product yourself. We shall not assume any responsibility for problems caused by unauthorized repair or maintenance.

#### Caution

- For the battery with + and - signs, + identifies the positive terminals of the device which is used with or generates direct current, and - identifies the negative terminals of the device which is used with or generates direct current.
- No naked flame sources, such as lighted candles, should be placed on the equipment.
- If the serial port of the device is used for debugging only, it is reserved only for professionals or technical support for device maintenance. Refer to the document for details.
- Attach the device properly to the floor/wall in accordance with the installation instructions to prevent injury. Refer to the document for details.
- DO NOT drop the product or subject it to physical shock. Do not install the product on vibratory surface or places.
- DO NOT expose the device to high electromagnetic radiation.
- DO NOT expose the device to extremely hot, cold, dusty, corrosive, saline-alkali, or damp environments. For temperature and humidity requirements, refer to the datasheet for details.
- DO NOT install indoor product where it may get wet by water or other liquid.
- To avoid fire hazard or electric shock, DO NOT expose the device to rain or extremely damp environments.
- Accessing to the Internet may cause network security problems. Please strengthen the protection of your personal information and data security. When you find that the device may have network security risks, please contact us in time.
- Proper configuration of all passwords and other security settings is the responsibility of the installer and/or end-user.
- Keep all wrappers after unpacking them for future use. In case of any failure occurred, you need to return the device to the factory with the original wrapper. Transportation without the original wrapper may result in damage on the device and the company shall not take any responsibilities.

#### Note

- This installation should be made by a qualified service person and should conform to all the local codes.

©2023 Hangzhou Hikvision Digital Technology Co., Ltd. All rights reserved.

#### About this Manual

The Manual includes instructions for using and managing the Product. Pictures, charts, images and all other information hereinafter are for description and explanation only. The information contained in the Manual is subject to change, without notice, due to firmware updates or other reasons. Please find the latest version of this Manual at the Hikvision website (<https://www.hikvision.com/>).

Please use this Manual with the guidance and assistance of professionals trained in supporting the Product.

#### Trademarks

HIKVISION and other Hikvision's trademarks and logos are the properties of Hikvision in various jurisdictions.

Other trademarks and logos mentioned are the properties of their respective owners.

#### Disclaimer

TO THE MAXIMUM EXTENT PERMITTED BY APPLICABLE LAW, THIS MANUAL AND THE PRODUCT DESCRIBED, WITH ITS HARDWARE, SOFTWARE AND FIRMWARE, ARE PROVIDED "AS IS" AND "WITH ALL FAULTS AND ERRORS". HIKVISION MAKES NO WARRANTIES, EXPRESS OR IMPLIED, INCLUDING WITHOUT LIMITATION, MERCHANTABILITY, SATISFACTORY QUALITY, OR FITNESS FOR A PARTICULAR PURPOSE. THE USE OF THE PRODUCT BY YOU IS AT YOUR OWN RISK. IN NO EVENT WILL HIKVISION BE LIABLE TO YOU FOR ANY SPECIAL, CONSEQUENTIAL, INCIDENTAL, OR INDIRECT DAMAGES, INCLUDING, AMONG OTHERS, DAMAGES FOR LOSS OF BUSINESS PROFITS, BUSINESS INTERRUPTION, OR LOSS OF DATA, CORRUPTION OF SYSTEMS, OR LOSS OF DOCUMENTATION, WHETHER BASED ON BREACH OF CONTRACT, TORT (INCLUDING NEGLIGENCE), PRODUCT LIABILITY, OR OTHERWISE, IN CONNECTION WITH THE USE OF THE PRODUCT, EVEN IF HIKVISION HAS BEEN ADVISED OF THE POSSIBILITY OF SUCH DAMAGES OR LOSS. YOU ACKNOWLEDGE THAT THE NATURE OF THE INTERNET PROVIDES FOR INHERENT SECURITY RISKS, AND HIKVISION SHALL NOT TAKE ANY RESPONSIBILITIES FOR ABNORMAL OPERATION, PRIVACY LEAKAGE OR OTHER DAMAGES RESULTING FROM CYBER-ATTACK, HACKER ATTACK, VIRUS INFECTION, OR OTHER INTERNET SECURITY RISKS; HOWEVER, HIKVISION WILL PROVIDE TIMELY TECHNICAL SUPPORT IF REQUIRED.

YOU AGREE TO USE THIS PRODUCT IN COMPLIANCE WITH ALL APPLICABLE LAWS, AND YOU ARE SOLELY RESPONSIBLE FOR ENSURING THAT YOUR USE CONFORMS TO THE APPLICABLE LAW. ESPECIALLY, YOU ARE RESPONSIBLE, FOR USING THIS PRODUCT IN A MANNER THAT DOES NOT INFRINGE ON THE RIGHTS OF THIRD PARTIES, INCLUDING WITHOUT LIMITATION, RIGHTS OF PUBLICITY, INTELLECTUAL PROPERTY RIGHTS, OR DATA PROTECTION AND OTHER PRIVACY RIGHTS. YOU SHALL NOT USE THIS PRODUCT FOR ANY PROHIBITED END-USES, INCLUDING THE DEVELOPMENT OR PRODUCTION OF WEAPONS OF MASS DESTRUCTION, THE DEVELOPMENT OR PRODUCTION OF CHEMICAL OR BIOLOGICAL WEAPONS, ANY ACTIVITIES IN THE CONTEXT RELATED TO ANY NUCLEAR EXPLOSIVE OR UNSAFE NUCLEAR FUEL-CYCLE, OR IN SUPPORT OF HUMAN RIGHTS ABUSES. IN THE EVENT OF ANY CONFLICTS BETWEEN THIS MANUAL AND THE APPLICABLE LAW, THE LATTER PREVAILS.

## 2 Interface

### Type I:

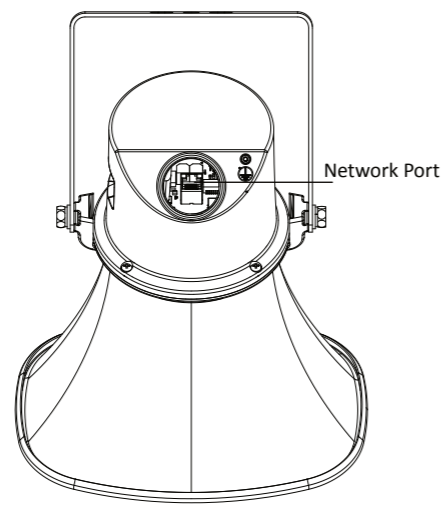

The network port of the type I device is located in the back cover. You can see it by unscrewing the back cover.

### Installation of Network Cables

- Unscrew the back cover of the device.
- Insert the network interface into the threading cap.
- Remove the waterproof structural component from the rubber plug.
- Thread the threading cap into the rubber plug on the back cover of the device and adjust the rubber plug to the appropriate position.
- Remove the threading cap and insert the network interface into the device's network port.
- Tighten the device back cover.

To ensure waterproof effect, the protruding structure of the rubber plug covering the network cable should face the outside of the equipment.

### Type II:

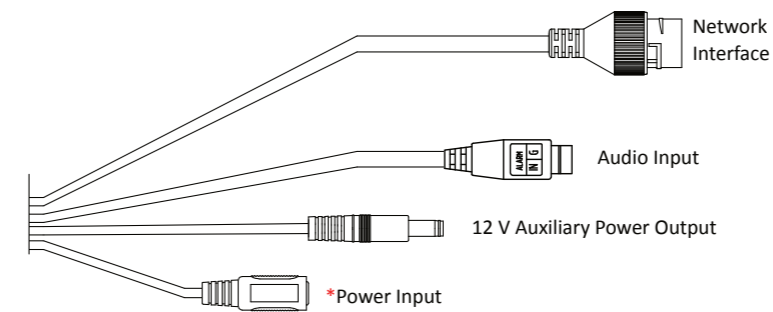

- 12 V auxiliary power output is used to supply power to accessories.
- Only certain models support power input and support 24 VDC power supply. Please refer to the actual device.

### 3 Installation



- Please make sure your power supply matches your device. Refer to datasheet for details.
- Complete wiring before installation.
- Make sure all the related equipment is power-off during the installation.

- 1 Align the fixing hole with the required fixing position, drill holes according to the fixing hole position, and fix the device to the fixing surface with screws.

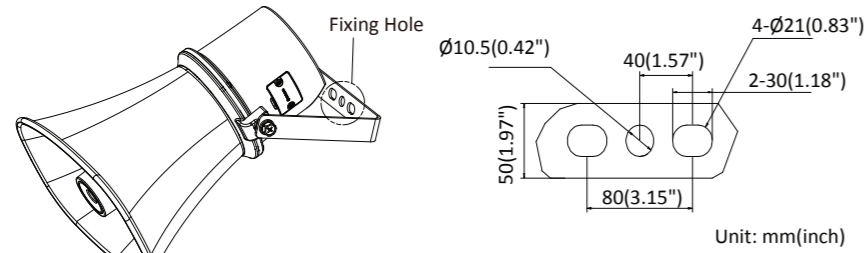

- 3 Adjust the bracket to proper angle.

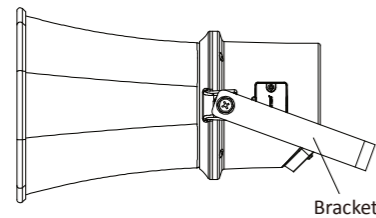

- 2 Loosen the screws.

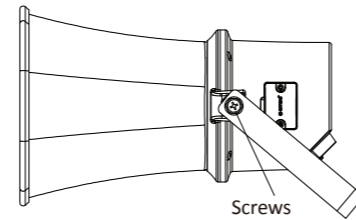

- 4 Tighten the screws.

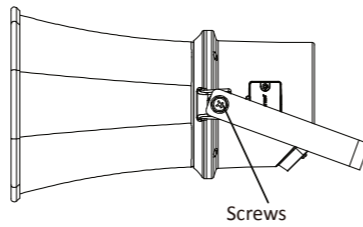

### 4 Quick Setup

You should activate the device before the first login. After powering on the device, the system will switch to Device Activation page.

#### ● Activate via Web Browser

1. Make sure the device IP address and the computer's should be in the same IP segment.
2. Enter the device default IP address (192.0.0.64) in the address bar of the web browser, and press **Enter**.
3. If you have more than one device in your network, please change the IP address of the device to prevent the abnormal access caused by IP address conflict. After logging in to the device, you can go to **Configuration -> Network -> Network Settings -> TCP/IP**, and modify the IP address, subnet mask, gateway and other parameters.



We highly recommend you change the password of your own choosing (using a minimum of 8 characters, including at least three kinds of following categories: upper case letters, lower case letters, numbers, and special characters) in order to increase the security of your product.

#### ● Network Settings

1. Go to **Configuration -> Network -> Network Settings -> TCP/IP** for parameter settings.
2. Network Parameter Settings
  - Manually enter the **IPv4 Address, IPv4 Subnet Mask, IPv4 Default Gateway, Preferred DNS Address and Alternate Address**.
  - Check **Auto DNS** to obtain the parameters automatically.
3. Click **Save**.

#### ● Broadcast Settings

1. Go to **Configuration -> Broadcast Settings -> Library** to import broadcast materials.
2. Go to **Configuration -> Broadcast Settings -> Scheduled Broadcast Settings** to create scheduled broadcast.

#### Note

For more information about settings, see **User Manual**.

Scan the QR Code to Get User Manual



**These clauses apply only to the products bearing the corresponding mark or information.**

#### EU/UK Compliance Statement

**CE** This product and - if applicable - the supplied accessories too are marked with "CE" and comply therefore with the applicable harmonized European standards listed under the Directive 2014/30/EU (EMCD) and Directive 2011/65/EU (RoHS).

Note: The products with the input voltage of within 50 to 1000 VAC or 75 to 1500 VDC comply with Directive 2014/35/EU (LVD), and the rest products comply with Directive 2001/95/EC (GPSD). Please check the specific power supply information for reference.

The full text of the EU declaration of conformity is available at the following internet address: <https://www.hikvision.com/en/support/compliance/declaration-of-conformity>.

**UK CA** This product and - if applicable - the supplied accessories too are marked with "UKCA" and comply therefore with the following directives: Electromagnetic Compatibility Regulations 2016, Electrical Equipment (Safety) Regulations 2016, the Restriction of the Use of Certain Hazardous Substances in Electrical and Electronic Equipment Regulations 2012.

Directive 2012/19/EU (WEEE Directive): Products marked with this symbol cannot be disposed of as unsorted municipal waste in the European Union. For proper recycling, return this product to your local supplier upon the purchase of equivalent new equipment, or dispose of it at designated collection points. For more information see: [www.recyclethis.info](http://www.recyclethis.info).

According to the Waste Electrical and Electronic Equipment Regulations 2013: Products marked with this symbol cannot be disposed of as unsorted municipal waste in the United Kingdom. For proper recycling, return this product to your local supplier upon the purchase of equivalent new equipment, or dispose of it at designated collection points. For more information see: [www.recyclethis.info](http://www.recyclethis.info).

Directive 2006/66/EC and its amendment 2013/56/EU (Battery Directive): This product contains a battery that cannot be disposed of as unsorted municipal waste in the European Union. See the product documentation for specific battery information. The battery is marked with this symbol, which may include lettering to indicate cadmium (Cd), lead (Pb), or mercury (Hg). For proper recycling, return the battery to your supplier or to a designated collection point. For more information see: [www.recyclethis.info](http://www.recyclethis.info).

According to the Batteries and Accumulators (Placing on the Market) Regulations 2008 and the Waste Batteries and Accumulators Regulations 2009: This product contains a battery that cannot be disposed of as unsorted municipal waste in the United Kingdom. See the product documentation for specific battery information. The battery is marked with this symbol, which may include lettering to indicate cadmium (Cd), lead (Pb), or mercury (Hg). For proper recycling, return the battery to your supplier or to a designated collection point. For more information see: [www.recyclethis.info](http://www.recyclethis.info).

**Industry Canada ICES-003 Compliance**  
This device meets the CAN ICES-003 (B) / NMB-003 (B) standards requirements.

**Conformité Industrie Canada ICES-003**  
Cet appareil répond aux exigences des normes CAN ICES-003 (B) / NMB-003 (B).

**KC**  
B급 기기: 이 기기는 가정용(B급) 전자파적합기기로서 주로 가정에서 사용하는 것을 목적으로 하며, 모든 지역에서 사용할 수 있습니다.